

# GARAŻ G-51 PARTER

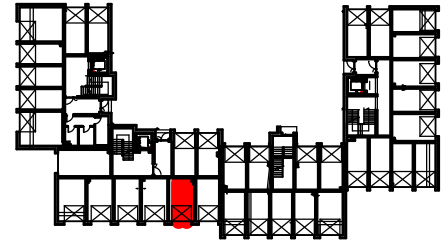

LOKALIZACJA W BUDYNKU

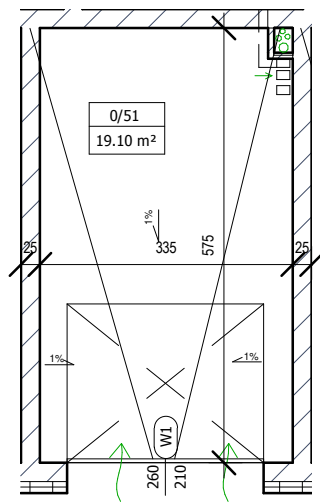

GARAŻ G 51		
0/51	Garaż	19,10m <sup>2</sup>



SKALA 1:100 (1cm=1m)

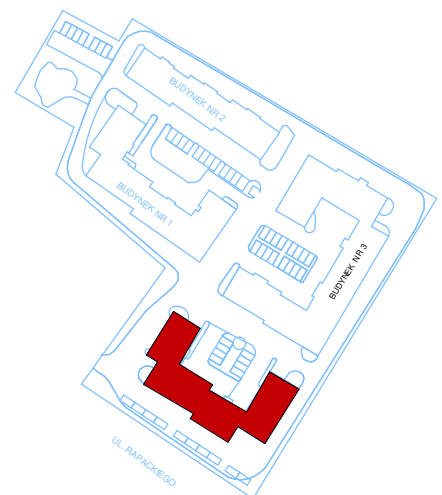

Plan osiedla