

GARAŻ G-48 PARTER

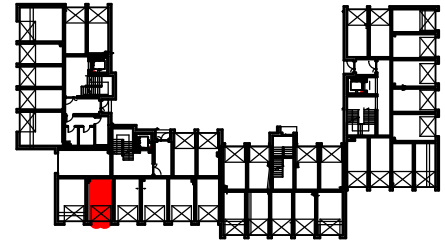

LOKALIZACJA W BUDYNKU

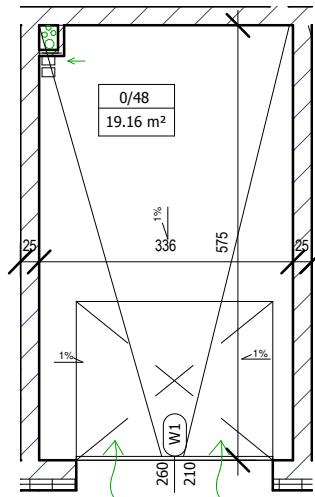

GARAŻ G 48		
0/48	Garaż	19,16m2



SKALA 1:100 (1cm=1m)

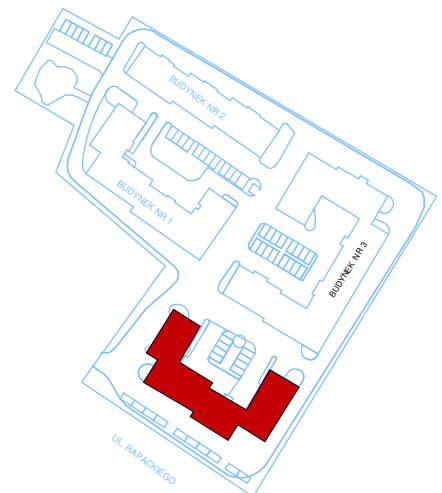

Plan osiedla