

GARAŻ G-28 PARTER

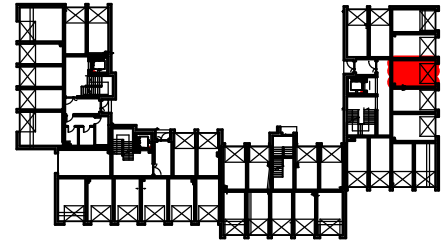

LOKALIZACJA W BUDYNKU

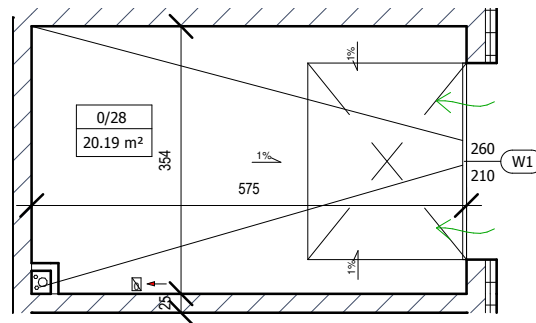

GARAŻ G 28		
0/28	Garaż	20,19m2



SKALA 1:100 (1cm=1m)

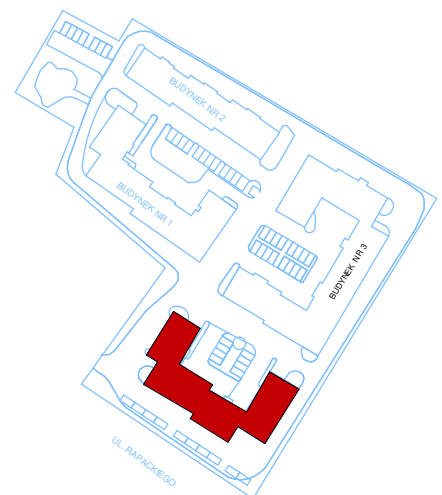

Plan osiedla